

# Fix Beam Expander 515...540 nm

## High-Power & Ultrashort Pulse Systems

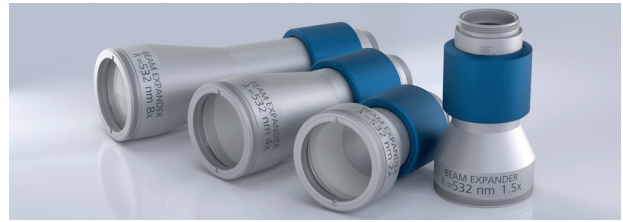

- Diffraction limited performance
- Divergence adjustable
- No internal foci
- Reverse mode possible



### Specification

Wavelength [nm]		1.5x	2x	4x	8x
515...540	GDD <sup>1)</sup>	659 fs <sup>2</sup>	659 fs <sup>2</sup>	659 fs <sup>2</sup>	989 fs <sup>2</sup>
	LIDT <sup>3)</sup>	CW: 2.5 MW/cm <sup>2</sup>   Pulsed (ns): 2.5 J/cm <sup>2</sup> * (τ/ns) <sup>0.35</sup>			
	Transmission	99 %	99 %	99 %	> 98 %
	Mounting	M30x1/M50x1	M30x1/M50x1	M30x1/M50x1	M30x1/M50x1
	Weight	0.243 kg	0.243 kg	0.297 kg	0.324 kg
	Clear input aperture	16 mm	16 mm	12 mm	7 mm
	Clear output aperture	40 mm	40 mm	40 mm	40 mm
	Diffraction limited up to an 1/e <sup>2</sup> diameter <sup>(2)</sup> of	8 mm	8 mm	5 mm	3 mm
	Order Number:	665477	665474	664780	664683

<sup>1)</sup> Group delay dispersion | <sup>2)</sup> beam diameter vignetted @ 1/e<sup>2</sup>

<sup>3)</sup> For UV lasers, the LIDT values are valid for pulse durations > 10 ps. For shorter pulses please be advised to test.

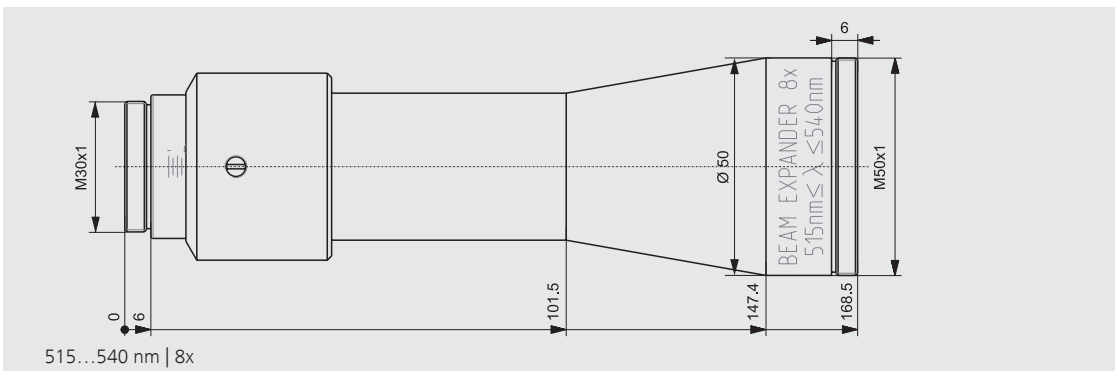
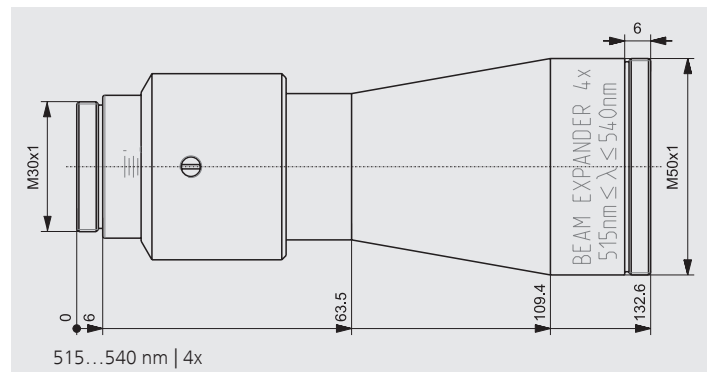
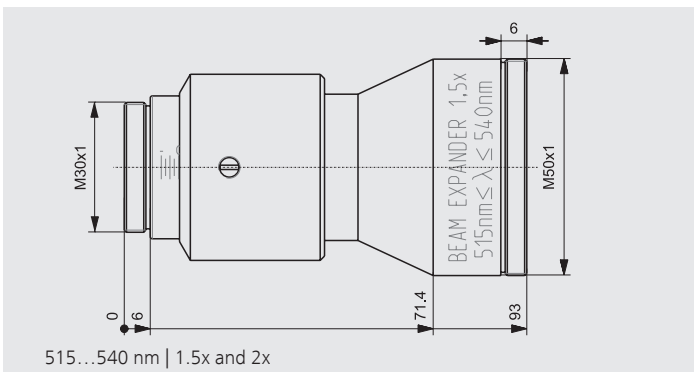

Registered Design in  
DE 40 2016 001 282.4  
Registered in CN, EU,  
HK, IN, JP, KR  
Pending in TW  
Granted Patent  
DE 10 2015 009 124  
Patent pending CN-,  
CZ-, KR-, US-App.

It is our policy to constantly improve the design and specifications. Accordingly, the details represented herein cannot be regarded as final and binding.